



DuraAct Piezoelectric Patch Transducer

FLEXIBLE, EFFICIENT, DURABLE

Versatile in Application

Efficient in Use

Structural Health Monitoring

When monitoring components, piezo transducers are used to measure deformations, e.g. the monitoring of weld seams on components that are difficult to access. Entire areas can be actively monitored by some of the transducers acting as wave-generating actuators, while other modules acting as sensors pick up these waves. Disturbances within a component, e.g. microcracks, are detected by comparison with reference signals from the undamaged system.

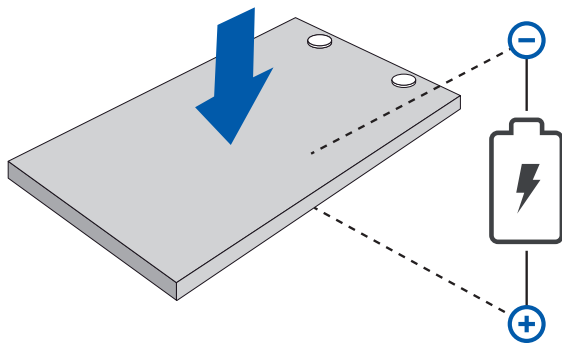
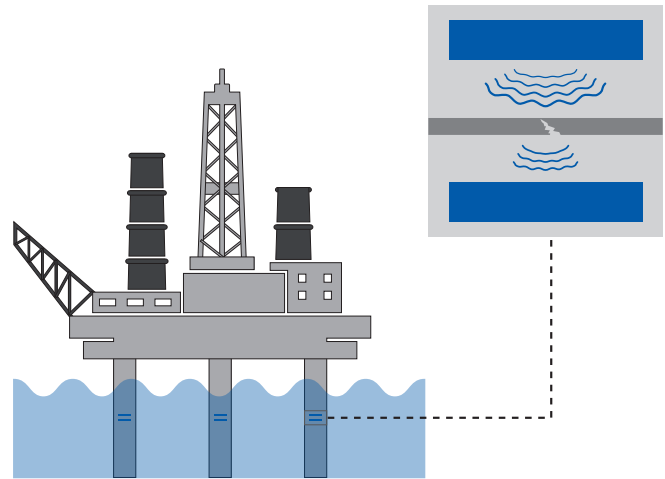

Energy-Autarkic Systems

DuraAct Patch Transducers use the direct piezoelectric effect to generate electricity – they convert the energy from vibrations and air currents, force changes or mechanical deformations into electricity and thus enable a self-sufficient supply of small electrical consumers such as sensors or radio transmitters.

Active Vibration and Sound Insulation

DuraAct Patch Transducers work both as a sensor and as an actuator and can thus dampen undesired vibrations. The phase-shifted sensor signal can also be used as voltage supply for the same piezo element.

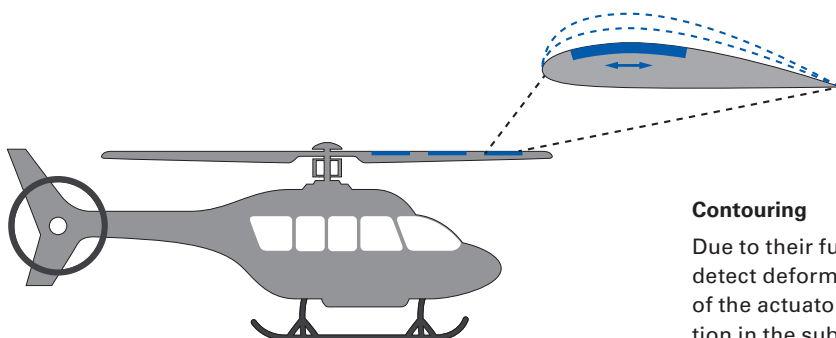
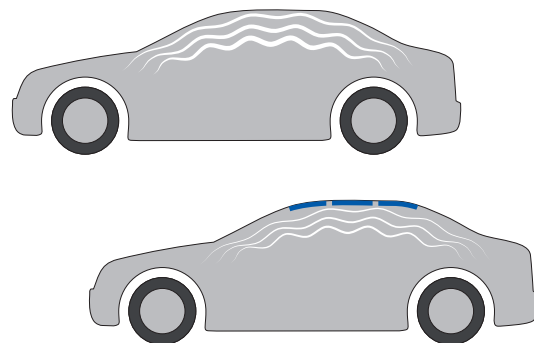

Contouring

Due to their function as sensors, DuraAct Patch Transducers detect deformations that are counteracted by the control of the actuator. This enables high-precision contour deformation in the sub-micrometer range.

DuraAct Patch Transducer

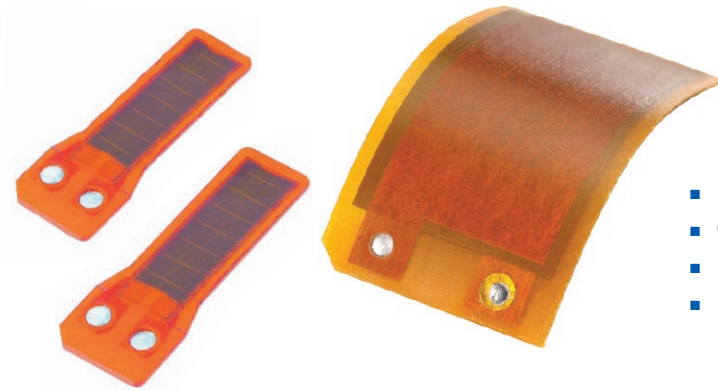

- Minimum bending radii up to 12 mm
- Compact design
- High bandwidth
- Individual solutions



DuraAct Patch Transducer



DuraAct Power Patch Transducer

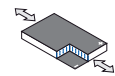

DuraAct Shear Patch Transducer

		DuraAct Patch Transducer				DuraAct Power Patch Transducer	DuraAct Shear Patch Transducer
		P-876.A11	P-876.A12	P-876.A15	P-876.SP1	P-878.A1	
	Operating voltage range [V]	-50 to 200	-100 to 400	-250 to 1.000	-100 to 400	-20 to 120	
Motion & positioning	Min. lateral/axial deformation [$\mu\text{m}/\text{m}$]	400	650	800	650	250/1.200	Customized development on request
	Rel. lateral/axial deformation [$\mu\text{m}/\text{V}$]	1,6	1,3	0,64	1,3	1,2/10	
Mechanical properties	Blocking force [N]	90	265	775	280	44	
	Min. bending radius [mm]	12	20	70	-	24	
Drive properties	Electrical capacitance [nF]	150 \pm 20 %	90 \pm 20 %	45 \pm 20 %	8 \pm 20 %	100 \pm 20 %	
	Piezoceramic material	PIC255	PIC255	PIC255	PIC255	PIC252	
	Active piezoceramic thickness [μm]	100	200	500	200	300	
Miscellaneous	Contacting	Solder points	Solder points	Solder points	Solder points	Solder points	
	Dimensions L x W x D (mm)	61 x 35 x 0,4	61 x 35 x 0,5	61 x 35 x 0,8	16 x 13 x 0,5	27 x 9,4 x 0,6	
	Recommended electronics	E-413, E-821, E-835	E-413, E-821, E-835	E-413, E-821, E-835	E-413, E-821, E-835	E-503, E-504, E-505, E-506, E-610, E-617, E-618, E-663, E-821, E-831, E-836	



Combined with suitable electronics, DuraAct Patch Transducers are the ideal solution for highly dynamic precise actuators with nanometer accuracy – discover our controllers at www.piceramic.com

Your Requirements

Your Customized Modification

DuraAct Patch Transducers are manufactured in a wide variety of shapes. Whether special geometries or electronics – we are happy to adapt our product to your application.

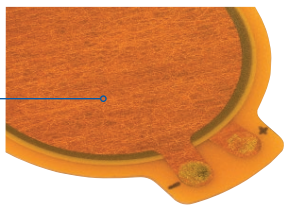

Dimensions and Geometries

- Broad selection
- Flexibility depending on the height of the piezoceramics
- Alternative piezoceramic materials on request

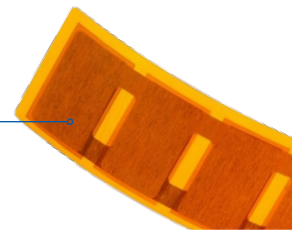

Arrays

- Incorporation of several DuraAct Patch Transducers in one laminate possible
- Contacting together or individually
- Piezoceramic construction in several layers for use of the DuraAct Patch Transducer as actuator and sensor

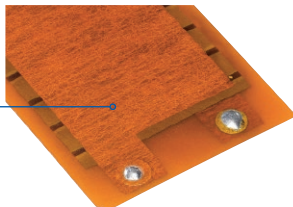

Electrical Connections

- Standard products with pre-tinned solder pads
- Customer-specific contacting variants with wires or strands possible

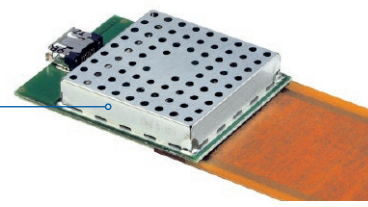

Special Electronics for Sensor Applications

- Electronic modules can be mounted close to the converter, e.g. for processing sensor data or controlling the DuraAct Patch Transducer
- Contacting via solder pins or mini plugs

Production with Know-how from the Space Industry

The piezoelectric plates of the DuraAct Patch Transducers are embedded in fiber-reinforced plastic (GRP) using a patented process and bonded to form a composite. Our partner INVENT takes over the joining process: A vacuum injection process produces completely bubble-free laminates of the highest quality. The curing temperature profile of the autoclave used for this purpose is selected in such a way that a defined internal preload of the piezoceramic plates is created. The polymer coating of the GRP serves simultaneously as electrical insulation and mechanical pretension.

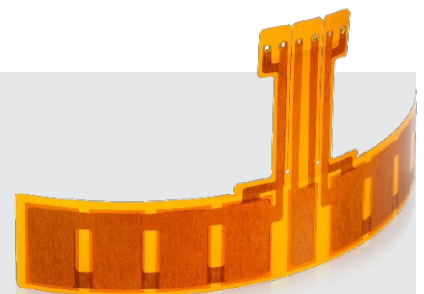

INVENT GmbH Braunschweig is a recognized lightweight construction specialist for innovative fiber composite technologies in the aerospace industry and develops and produces high-precision structural components for PI Ceramic, among others.

DuraAct Patch Transducers

Piezo Ceramics as Flexible Composites

DuraAct Patch Transducers are composites of one or more thin piezoceramic plates in a patented laminate structure: Piezo components equipped with electrodes are electrically insulated and mechanically pre-stressed by a polymer outer surface. Depending on the application, strands can be soldered, glued or clamped at two contact points. If the patch transducer is to have a separate sensor or actuator functionality, several layers are contacted separately.

- Application as sensor and actuator
- Extremely durable
- Flexible deformation
- Solid state actuators without friction and wear

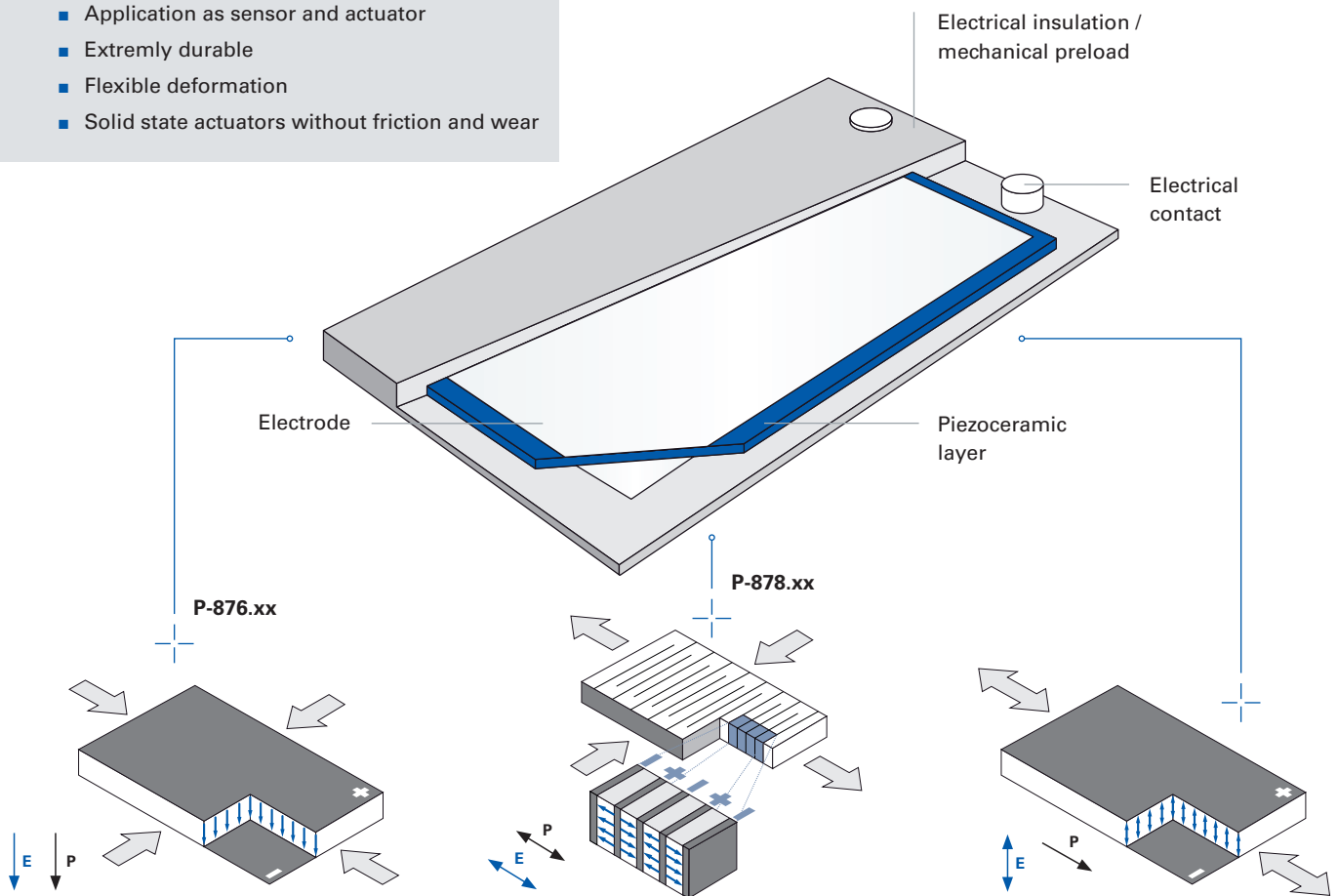

DuraAct Patch Transducers

- Longitudinal and transversal contraction or expansion of the patch transducer
- Moderate deflection up to max. 800 $\mu\text{m}/\text{m}$
- Minimum bending radii up to 12 mm
- Voltage range up to max. 1,000 V

DuraAct Power Patch Transducers

- Longitudinal deflection in transverse contraction
- High axial deflection up to max. 1,200 $\mu\text{m}/\text{m}$
- Greater efficiency through multilayer design
- Voltage range up to max. 120 V

DuraAct Shear Patch Transducers

- Shear movement of the patch transducer
- Generation of surface acoustic waves
- Voltage range up to max. 500 V



Learn more about DuraAct technology at www.piceramic.com



Headquarters

GERMANY

PI Ceramic GmbH
Lindenstrasse
07589 Lederhose
Phone +49 36604 882-0
Fax +49 36604 882-4109
info@piceramic.com
www.piceramic.com

Physik Instrumente (PI) GmbH & Co. KG

Auf der Roemerstrasse 1
76228 Karlsruhe
Phone +49 721 4846-0
Fax +49 721 4846-1019
info@pi.ws
www.pi.ws

PI miCos GmbH

Freiburger Strasse 30
79427 Eschbach
Phone +49 7634 5057-0
Fax +49 7634 5057-99
info@pimicos.com
www.pi.ws

© Physik Instrumente (PI) GmbH & Co. KG

All contents, including texts, graphics, data etc., as well as their layout, are subject to copyright and other protective laws. Any copying, modification or redistribution in whole or in parts is subject to a written permission of PI.

Although the information in this document has been compiled with the greatest care, errors cannot be ruled out completely. Therefore, we cannot guarantee for the information being complete, correct and up to date. Illustrations may differ from the original and are not binding. PI reserves the right to supplement or change the information provided without prior notice.

Follow us on:



ACS Motion Control

ISRAEL

ACS Motion Control Ltd.
Ramat Gabriel Industrial Park
1 Hataasia St.
Migdal HaEmek, 2307037
POB 984
Phone +972-4-6546440
Fax +972-4-6546443
info@acsmotioncontrol.com
www.acsmotioncontrol.com



PI Subsidiaries

USA (East) & CANADA

PI (Physik Instrumente) L.P.
Auburn, MA 01501
www.pi-usa.us

USA (San Francisco Bay Area)

PI (Physik Instrumente) L.P.
Sausalito, CA 94965
www.pi-usa.us

ITALY

Physik Instrumente (PI) S. r. l.
Bresso
www.pionline.it

FRANCE

PI France SAS
Aix-en-Provence
www.pi.ws

JAPAN

PI Japan Co., Ltd.
Tokyo
www.pi-japan.jp

CHINA

Physik Instrumente (PI Shanghai) Co., Ltd.
Shanghai
www.pi-china.cn

SOUTHEAST ASIA

PI (Physik Instrumente) Singapore LLP
Singapore
www.pi-singapore.sg
For ID / MY / PH / SG / TH / VNM

KOREA

PI Korea Ltd.
Seoul
www.pikorea.co.kr

USA (West) & MEXICO

PI (Physik Instrumente) L.P.
Irvine, CA 92620
www.pi-usa.us

UK & IRELAND

PI (Physik Instrumente) Ltd.
Cranfield, Bedford
www.physikinstrumente.co.uk

NETHERLANDS

PI Benelux B.V.
Sint-Oedenrode
www.pi.ws/benelux

SPAIN

Micos Iberia S.L.
Vilanova i la Geltrú
www.pimicos.es

PI Japan Co., Ltd.
Osaka
www.pi-japan.jp

Physik Instrumente (PI Shanghai) Co., Ltd.
Beijing
www.pi-china.cn

TAIWAN

Physik Instrumente (PI) Taiwan Ltd.
Taipei
www.pi-taiwan.com.tw